

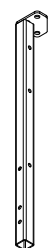

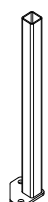







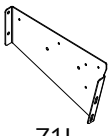
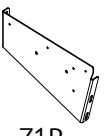

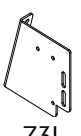

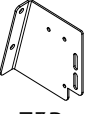

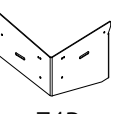
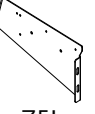
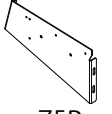

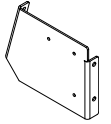
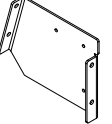
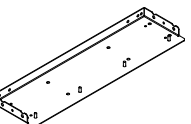
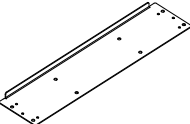
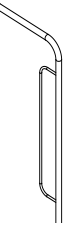

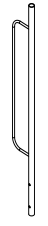
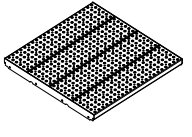
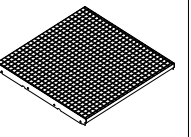
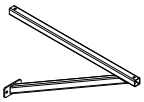
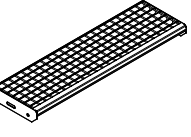
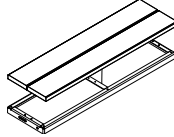



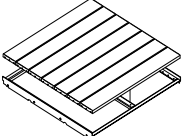
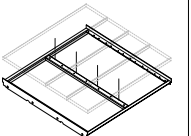

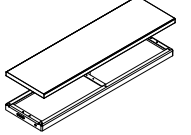
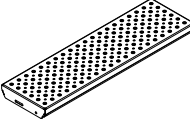

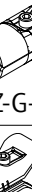
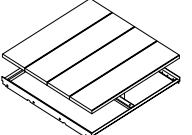
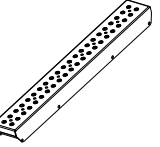
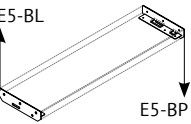

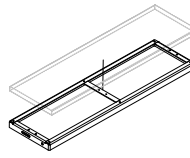

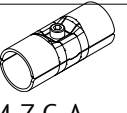
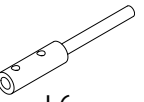



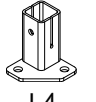



INSTRUKCJA MONTAŻU
ASSEMBLY INSTRUCTION
MONTAGEANLEITUNG

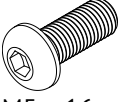
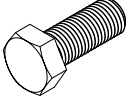
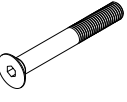
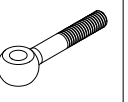
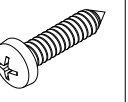

WYKAZ CZĘŚCI / PARTS LIST / STÜCKLISTE

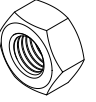
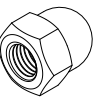
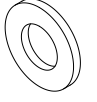
									
SZ1A	S0.5, S1, S2, S3	SZ2A, SZ3A	RP11, RP12, RP13	Z1L	Z1P	Z2L	Z2P	Z3L	
									
PO1.2 / PO2.4				Z3P	Z4L	Z4P	Z5L	Z5P	
									
PP1.2 / PP2.4				MSPL	MSPP	PD4	PD5		
									
R5B, R8B	R5P, R8P	R6B, R9B	PW1	PW4	PW4	E1	E2		
									
R6P, R9P	R7B	R7P	PW2	PWR	PWR	E3	E4		
									
R6P, R9P	R7B	R7P	PW3	D1, D2, D3, D4	E5	E5-BL E5-BP	ER		
									
XL1, XL2	M-Z-G-A	L6	ZW-28	WSP	LS	L4			
									
M-EB-01	M-Z-G	WF8	M-EB-05	RO28	M-EB-04	SG			
									
M5 x 16 M8 x 20 M8 x 50 M10 x 25 M10 x 40 M10 x 70 M12 x 30	M8 x 20 M8 x 50 M10 x 30 M10 x 60 M10 x 70 M12 x 30	MS5 x 40	M6 x 40	WK4,2 x 16	WD4 x 50 WD3,5 x 20	M6 M8 M10 M12	MK5 MK6	W8 W10 W12	WS8 WS10 WS12

POTRZEBNE DO MONTAŻU / NEEDED TO ASSEMBLY / FÜR DIE MONTAGE NOTWENDIG

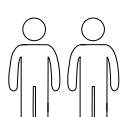
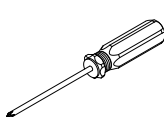
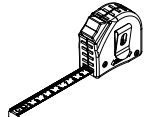
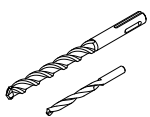
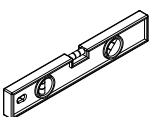
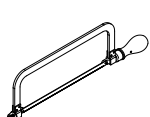
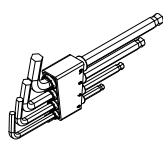
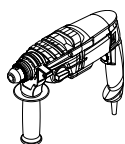
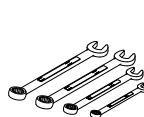

8,10 13, 17, 19 x 2

2, 3, 5, 6

14 mm, 2,5 mm,
11 mm

WARIANTY / VARIANTS / OPTIONEN

Barierka z wypełnieniem
Railing with the filling
Geländer mit Füllung

Barierka bez wypełnienia
Railing without the filling
Geländer ohne Füllung

Barierka z rurkami fi 12 mm
Railing with fi 12 mm tubes
Geländer mit Rohren fi 12 mm

Barierka z linkami fi 4 mm
Railing with fi 4 mm lines
Geländer mit Seilen fi 4 mm

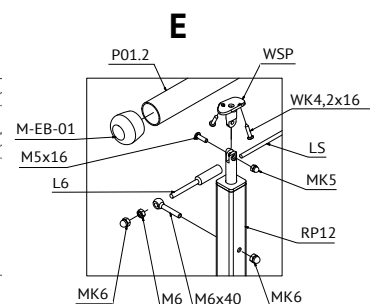
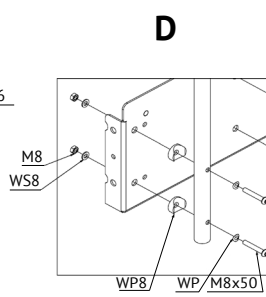
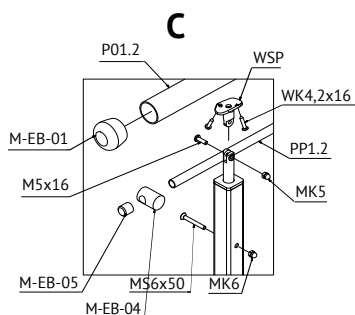
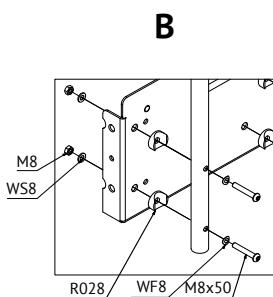
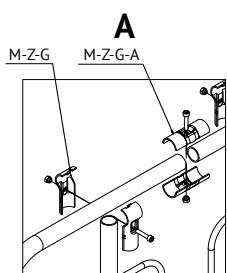
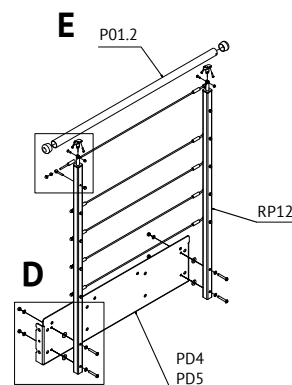
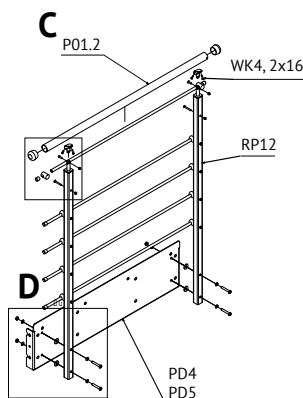
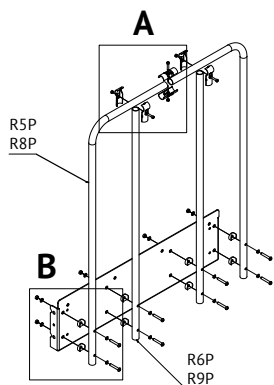
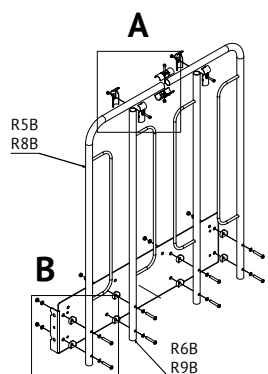

USTALENIE WYSOKOŚCI STOPNIA / HEIGHT OF TREAD ASSIGNMENT / BESTIMMUNG DER STUFENHÖHE

Przykładowe obliczenia / example calculations / Musterberechnungen

H = 1500 mm

N = 8

$$S = \frac{1500}{8} \approx 187,5 \text{ mm}$$

N - ilość stopni /
number of treads /
Anzahl der Stufen

S - wysokość stopni /
height of treads /
Stufenhöhe

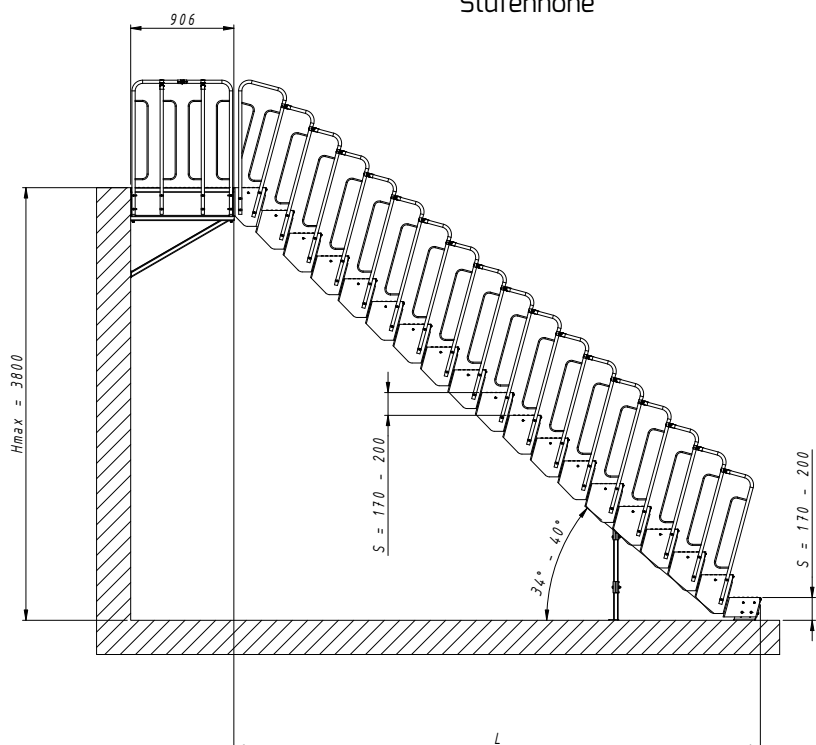

H	L	N
340-400	530-522	2
510-600	779-762	3
680-800	1027-1003	4
850-1000	1276-1244	5
1020-1200	1525-1485	6
1190-1400	1774-1725	7
1360-1600	2022-1966	8
1530-1800	2271-2207	9
1700-2000	2520-2447	10
1870-2200	2769-2688	11
2040-2400	3017-2929	12
2210-2600	3266-3170	13
2380-2800	3515-3410	14
2550-3000	3770-3657	15
2720-3200	4020-3900	16
2890-3400	4270-4140	17
3060-3600	4520-4381	18
3230-3800	4770-4622	19

Wymiar S regulowany płynnie w zakresie od 170 mm do 200 mm. Wszystkie wymiary podane w mm.

Dimension S is smoothly adjusted in range from 170 mm to 200 mm. All dimensions are in mm.

Die Größe S ist Stufenlos einstellbare im Bereich von 170 mm bis 200 mm. Alle Größe sind in mm angegeben.

WYKAZ ORAZ MONTAŻ STOPNI
 WARIANTS AND ASSEMBLY OF STEPS
 OPTIONEN UND MONTAGE VON STUFEN

DESKA TARASOWA
 OUTDOOR NON-SLIP BOARD
 BRETTER FÜR DEN AUSSENBEREICH
 128x890x25

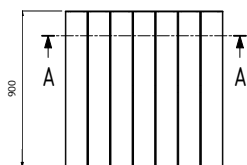
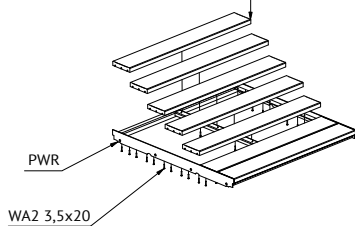
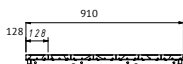

DESKA KLEJONA
 INDOOR LAMINATED TIMBER
 BRETTER FÜR DEN INNENBEREICH
 890X227X25

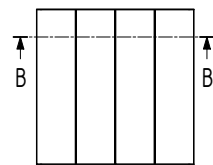
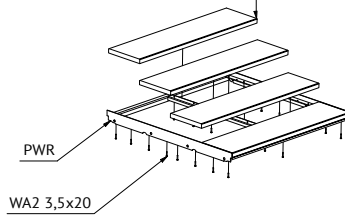
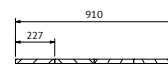

ASTA-E11L

ASTA-E12L

ASTA-E10L

ASTA-E5L

ASTA-E6L

ASTA-E4L

ASTA-E8L

ASTA-E7L

ASTA-E9L

ASTA-E2L

ASTA-E3L

ASTA-E1L

ASTA-ER5L

ASTA-ER6L

ASTA-ER4L

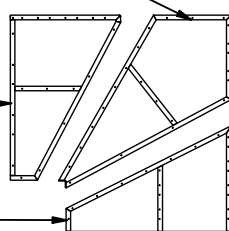
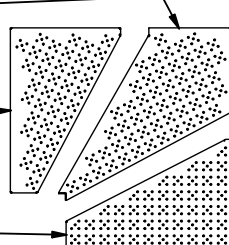
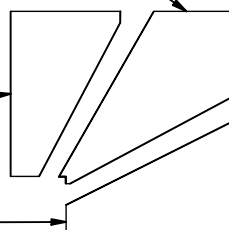
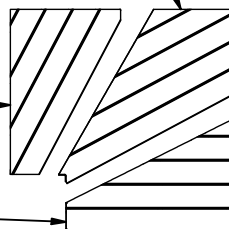
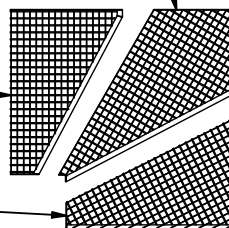

ASTA-E11P

ASTA-E12P

ASTA-E10P

ASTA-E5P

ASTA-E6P

ASTA-E4P

ASTA-E8P

ASTA-E7P

ASTA-E9P

ASTA-E2P

ASTA-E3P

ASTA-E1P

ASTA-ER5P

ASTA-ER6P

ASTA-ER4P

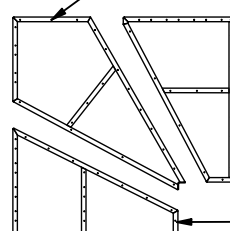
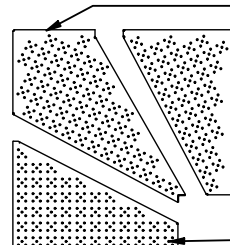
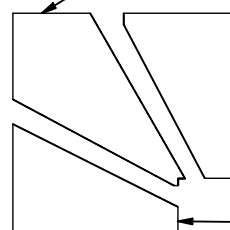
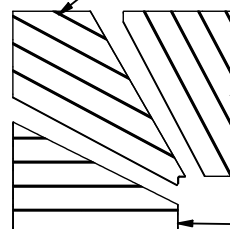
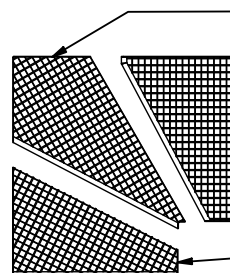

WYMIARY SYSTEMU ASTA /
 DIMENSIONS OF ASTA SYSTEM /
 ASTA SYSTEM ABMESSUNGEN

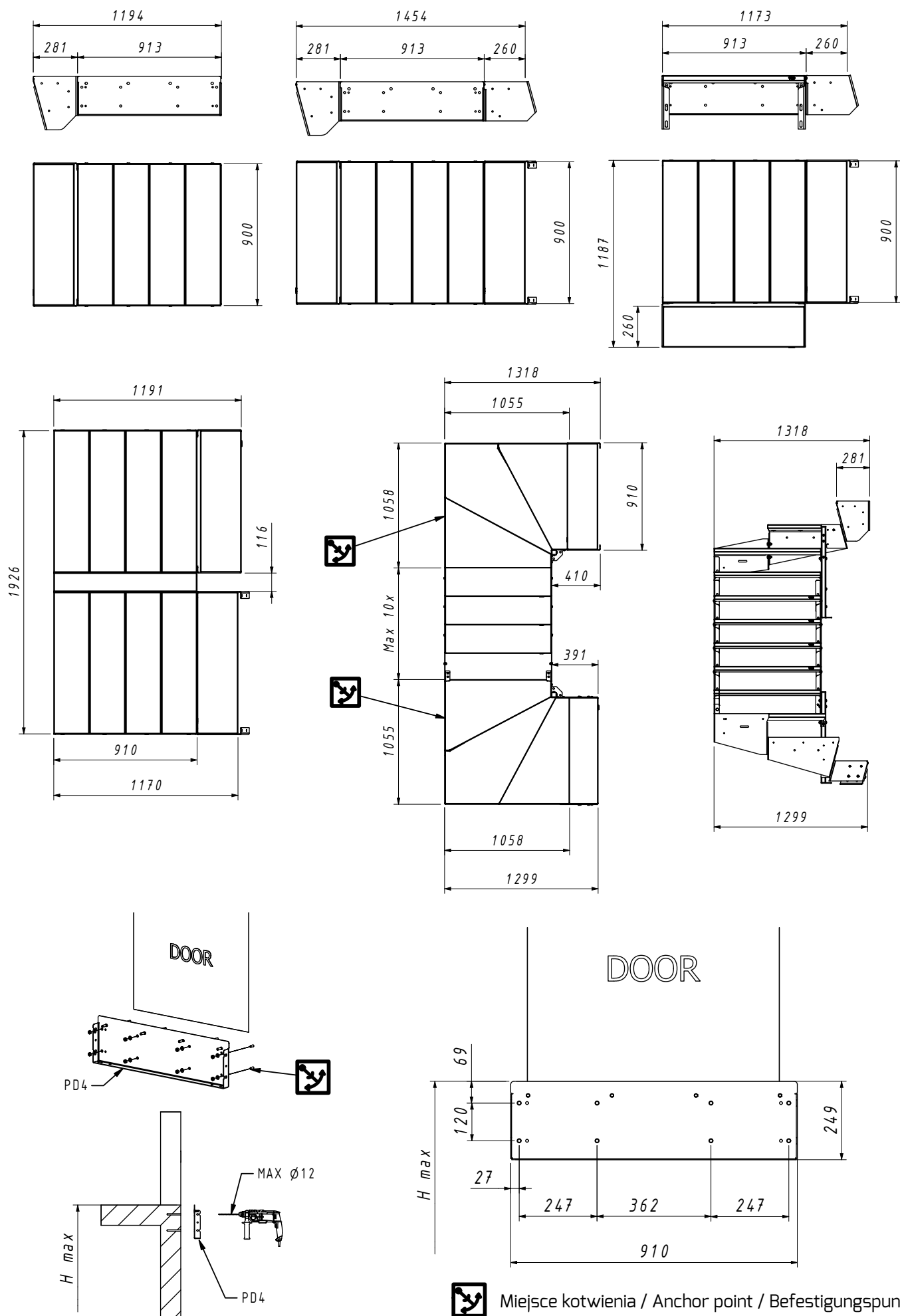

Miejsce kotwienia / Anchor point / Befestigungspunkt

Wariant 1 / Variant 1 / Variante 1

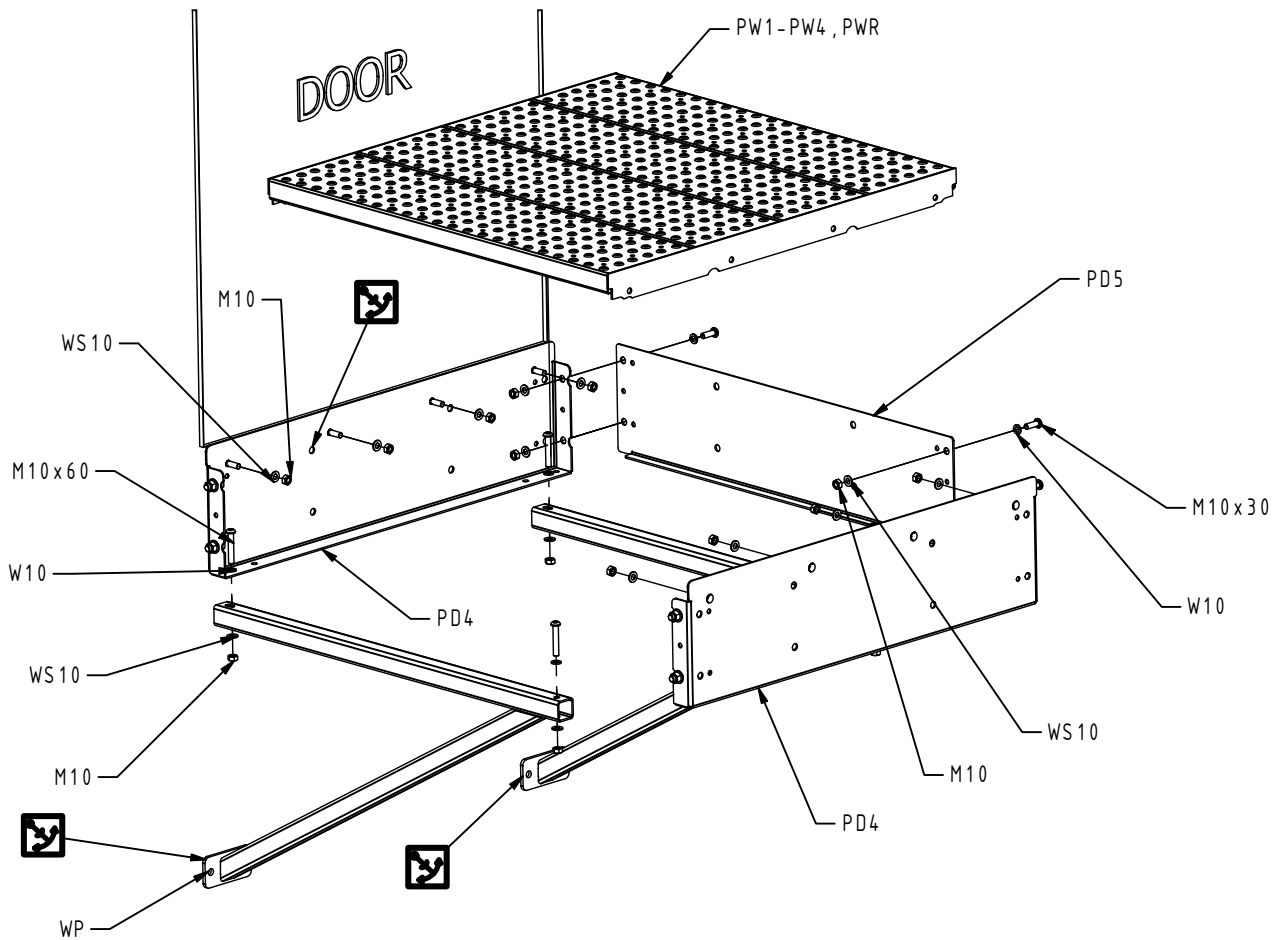

Wariant 2 / Variant 2 / Variante 2

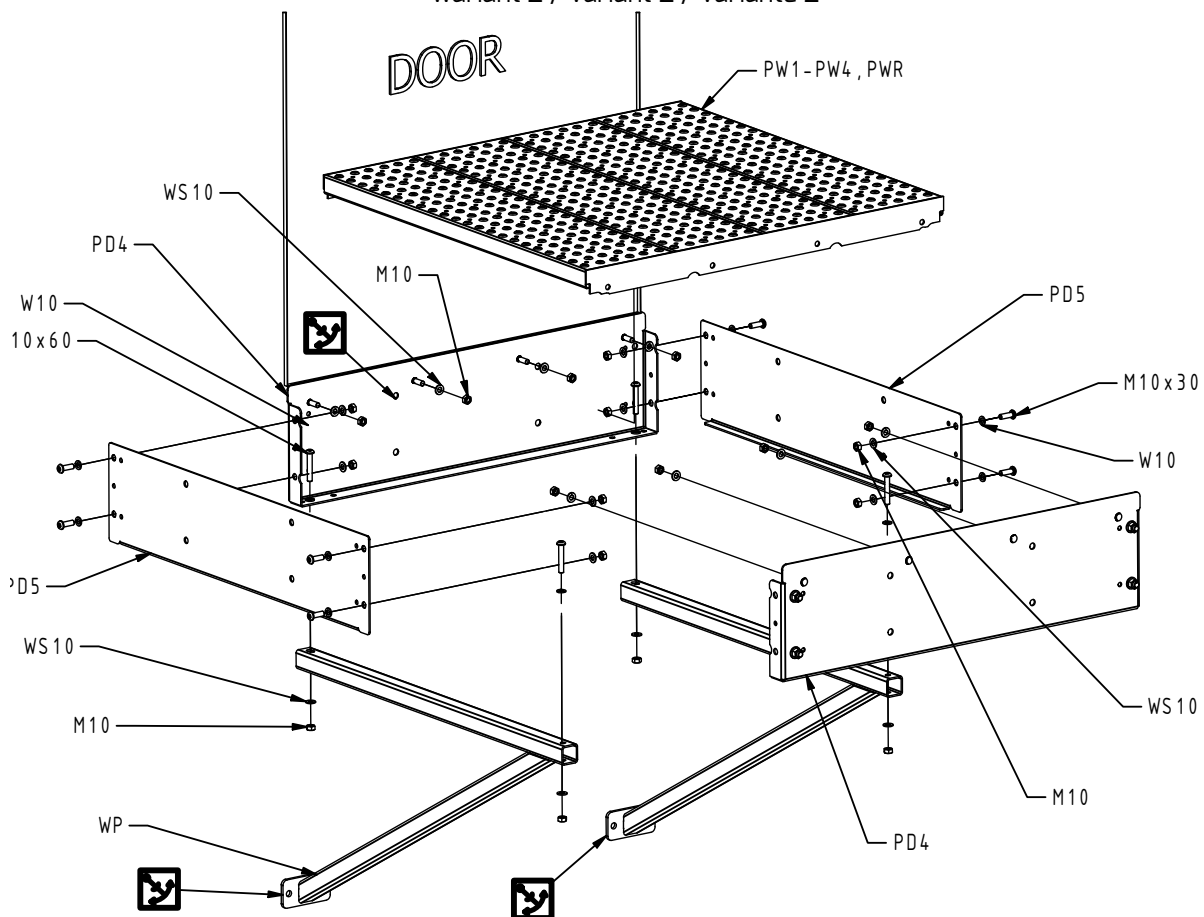

Wariant 3 / Variant 3 / Variante 3

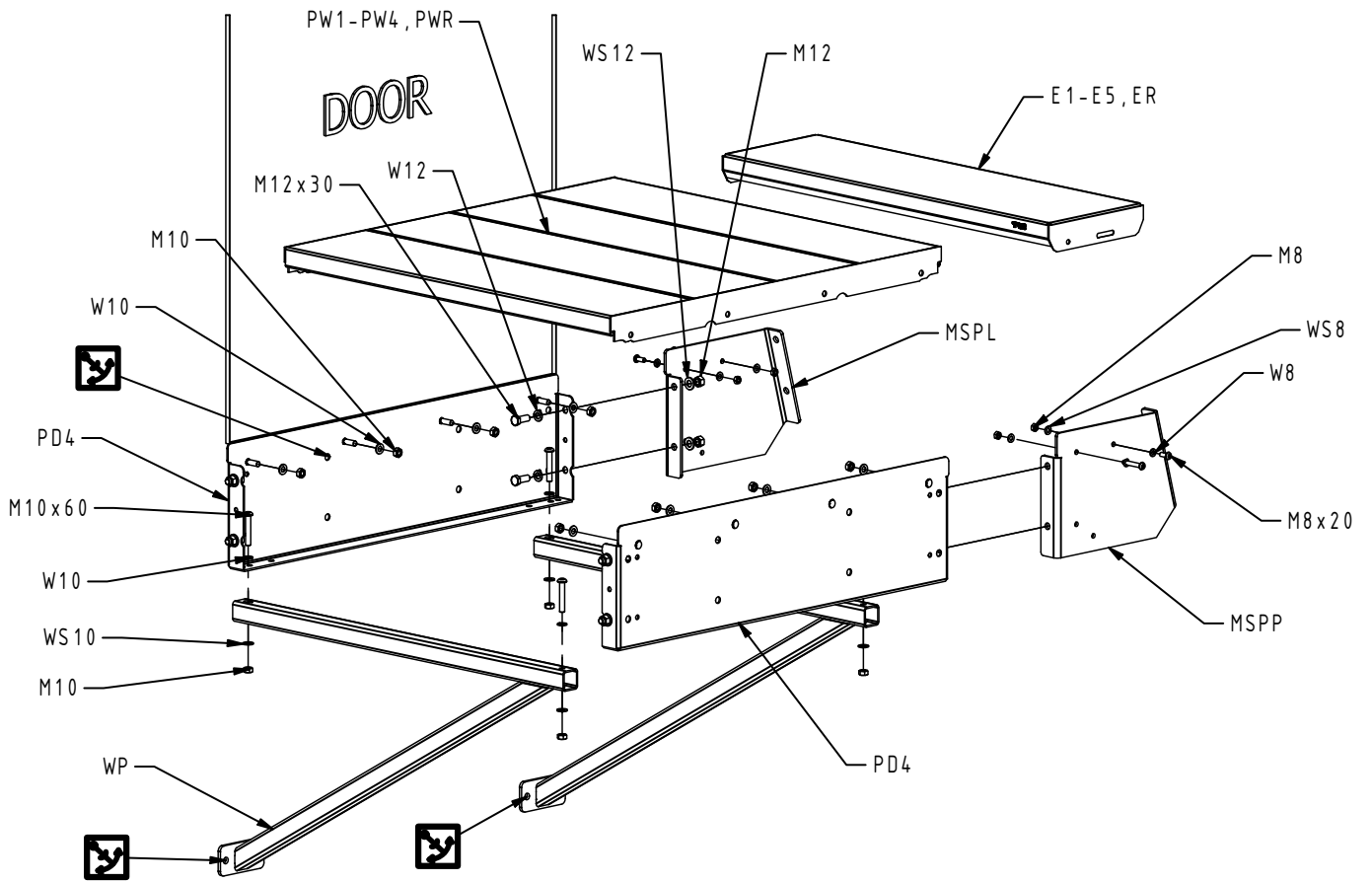

Wariant 4 / Variant 4 / Variante 4

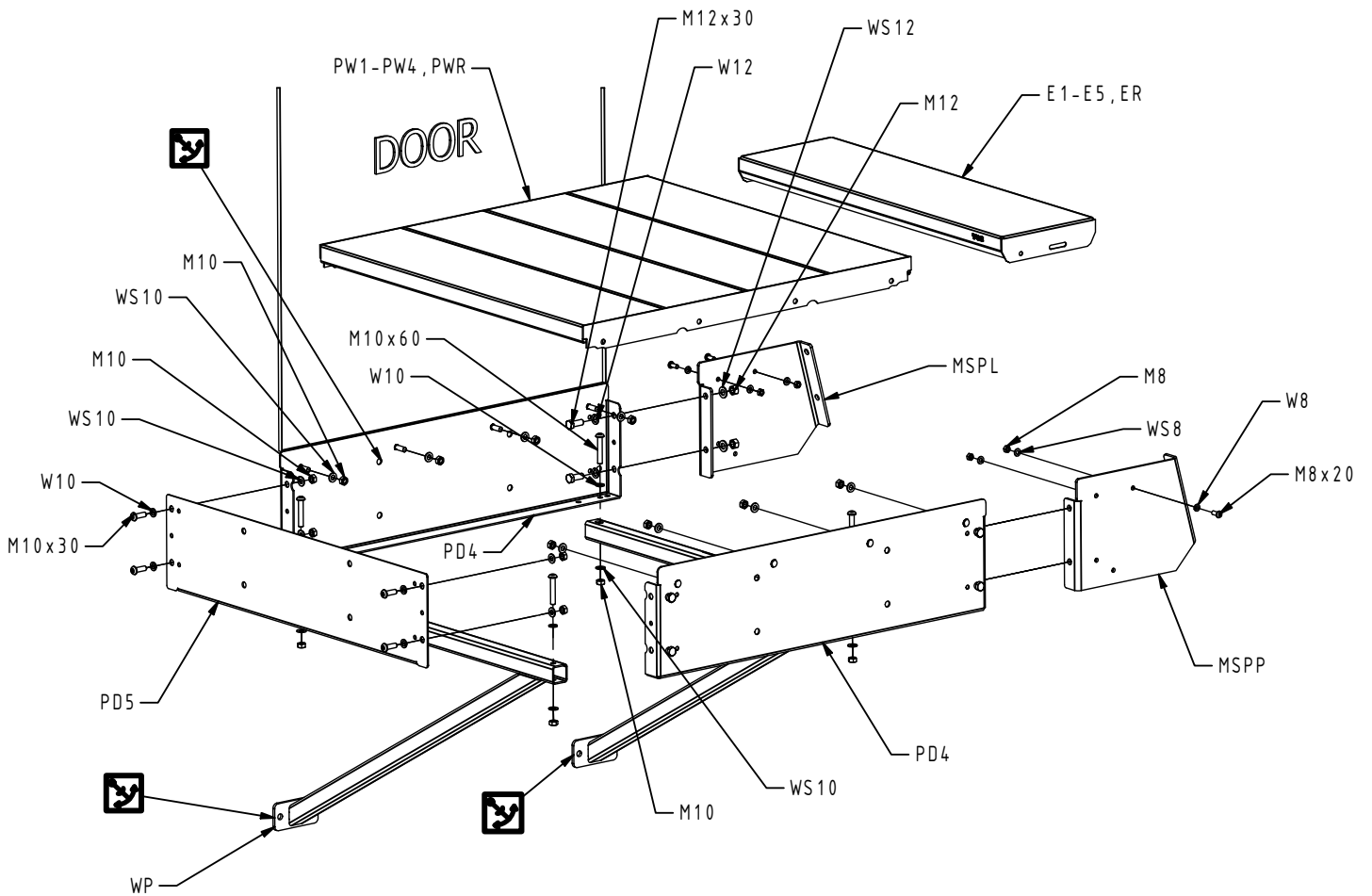

Wariant 5 / Variant 5 / Variante 5

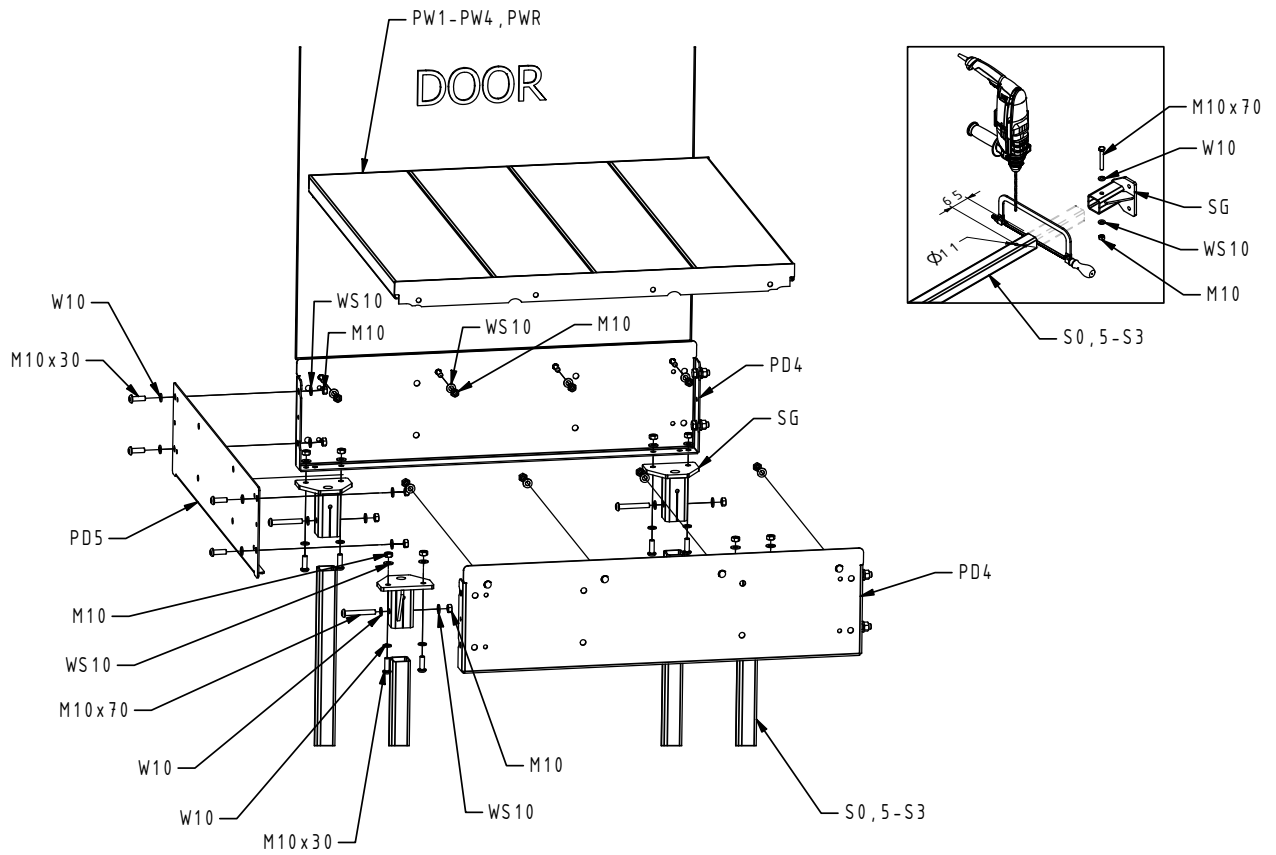

Wariant 6 / Variant 6 / Variante 6

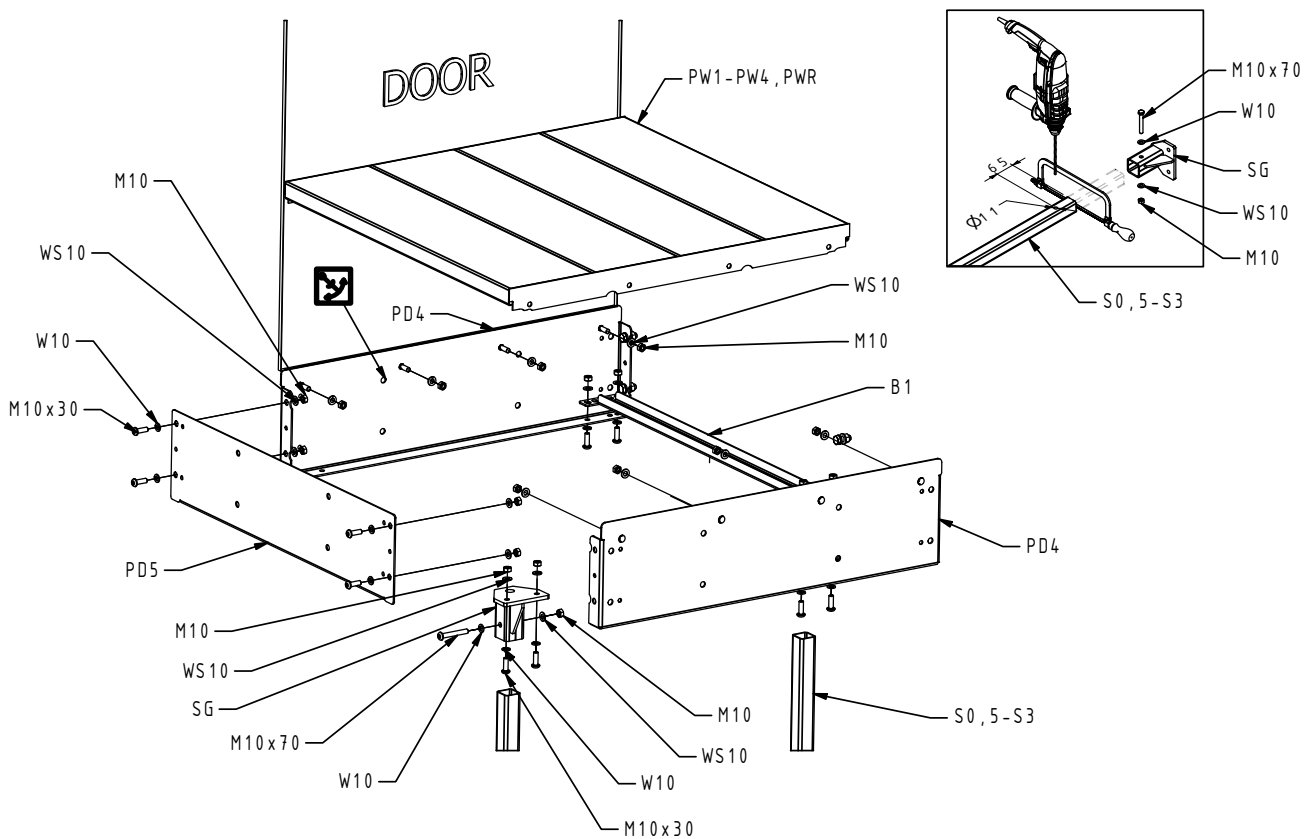

Variante 7 / Variant 7 / Variante 7

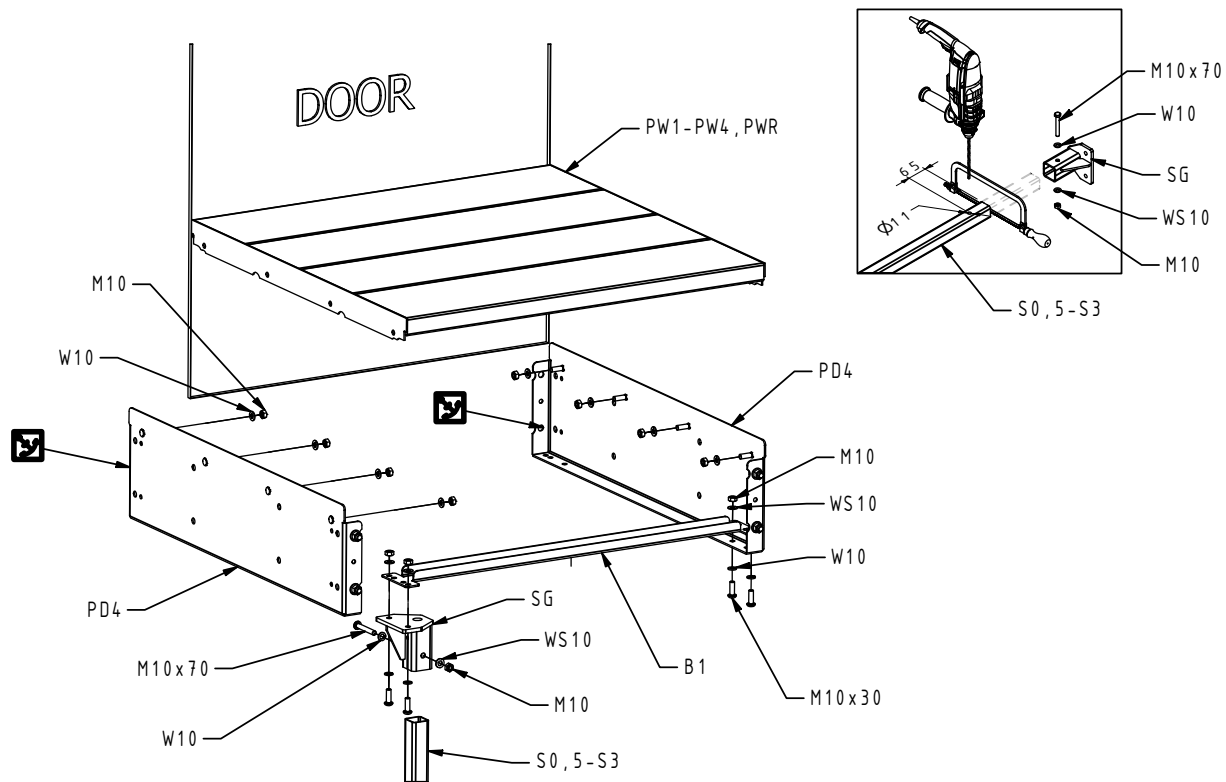

Variante 8 / Variant 8 / Variante 8

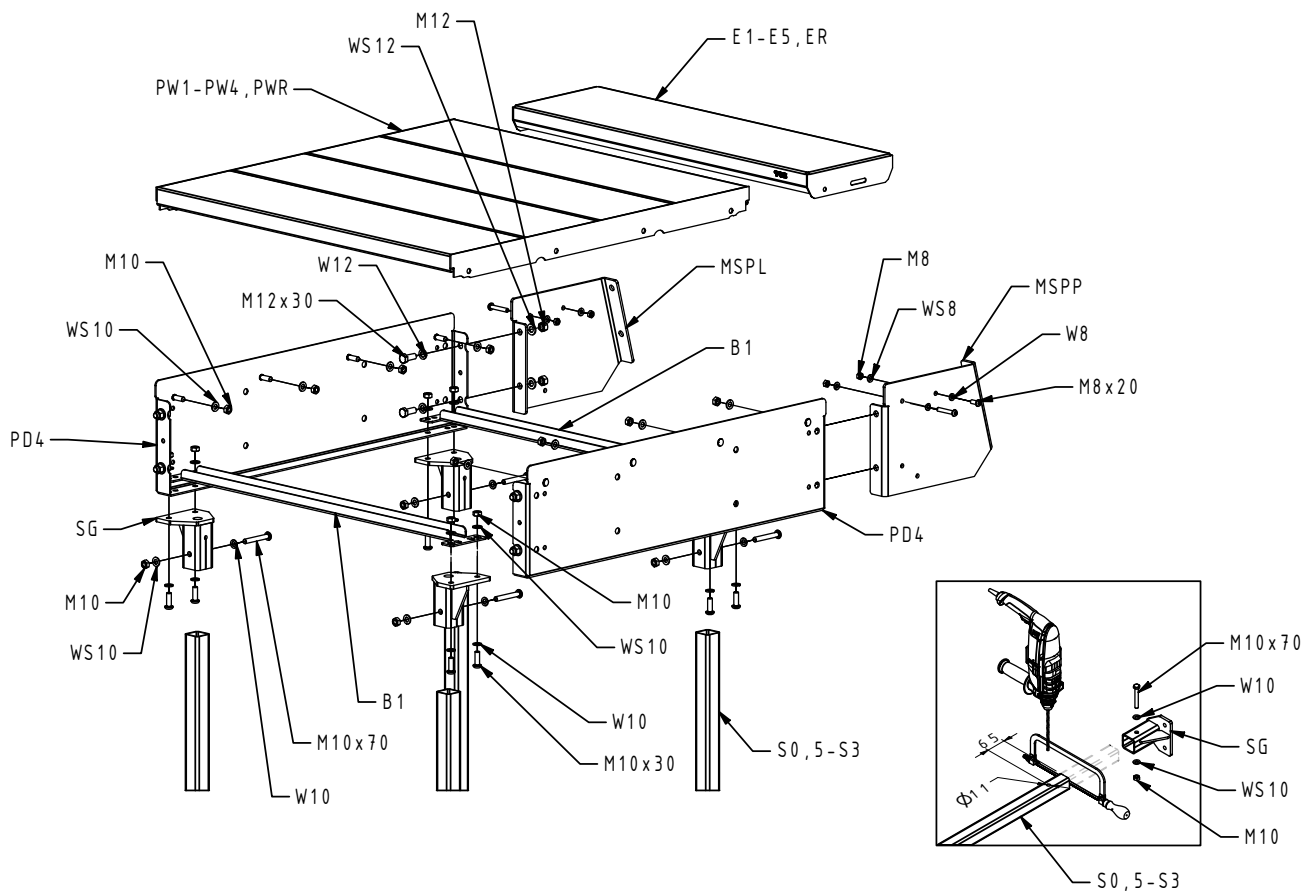

Wariant 11 / Variant 11 / Variante 11

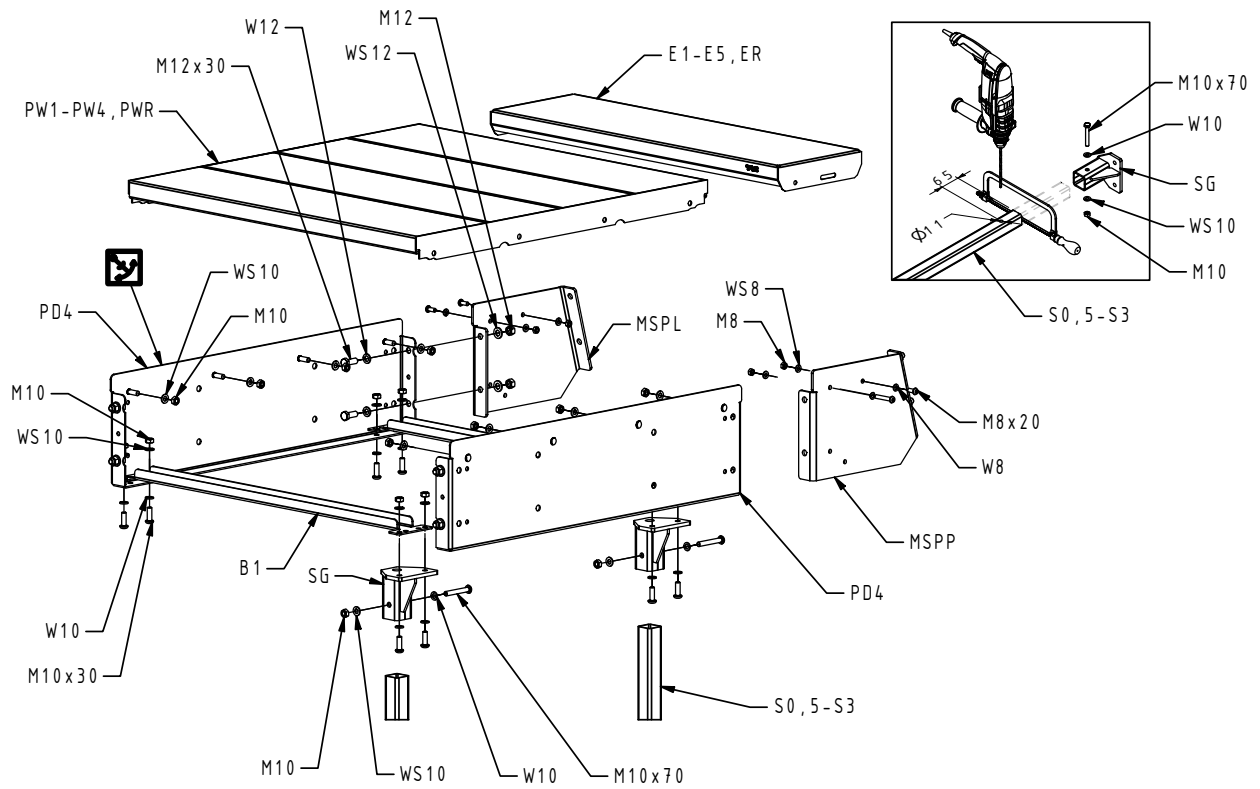

Wariant 12 / Variant 12 / Variante 12

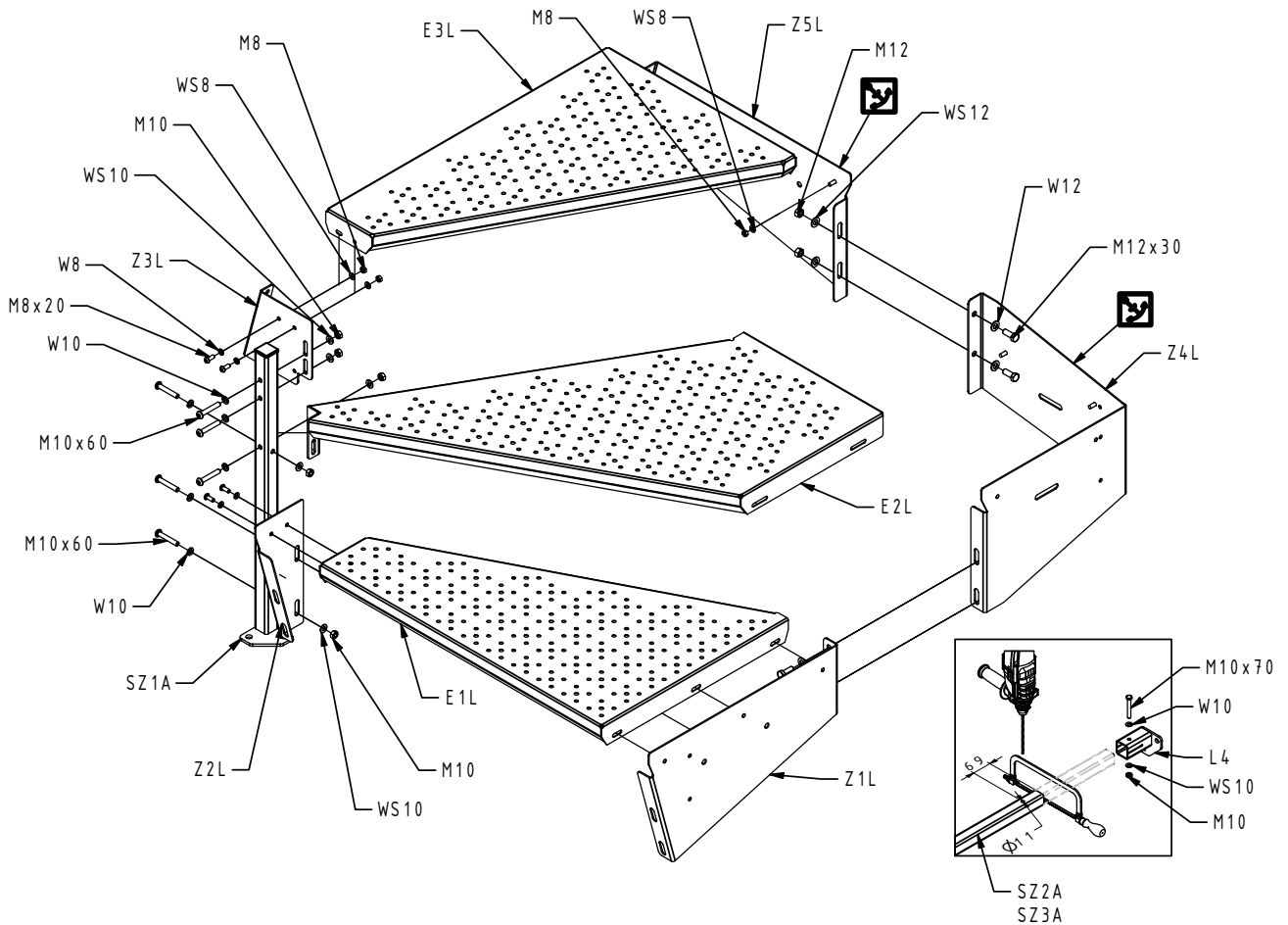

Wariant 13 / Variant 13 / Variante 13

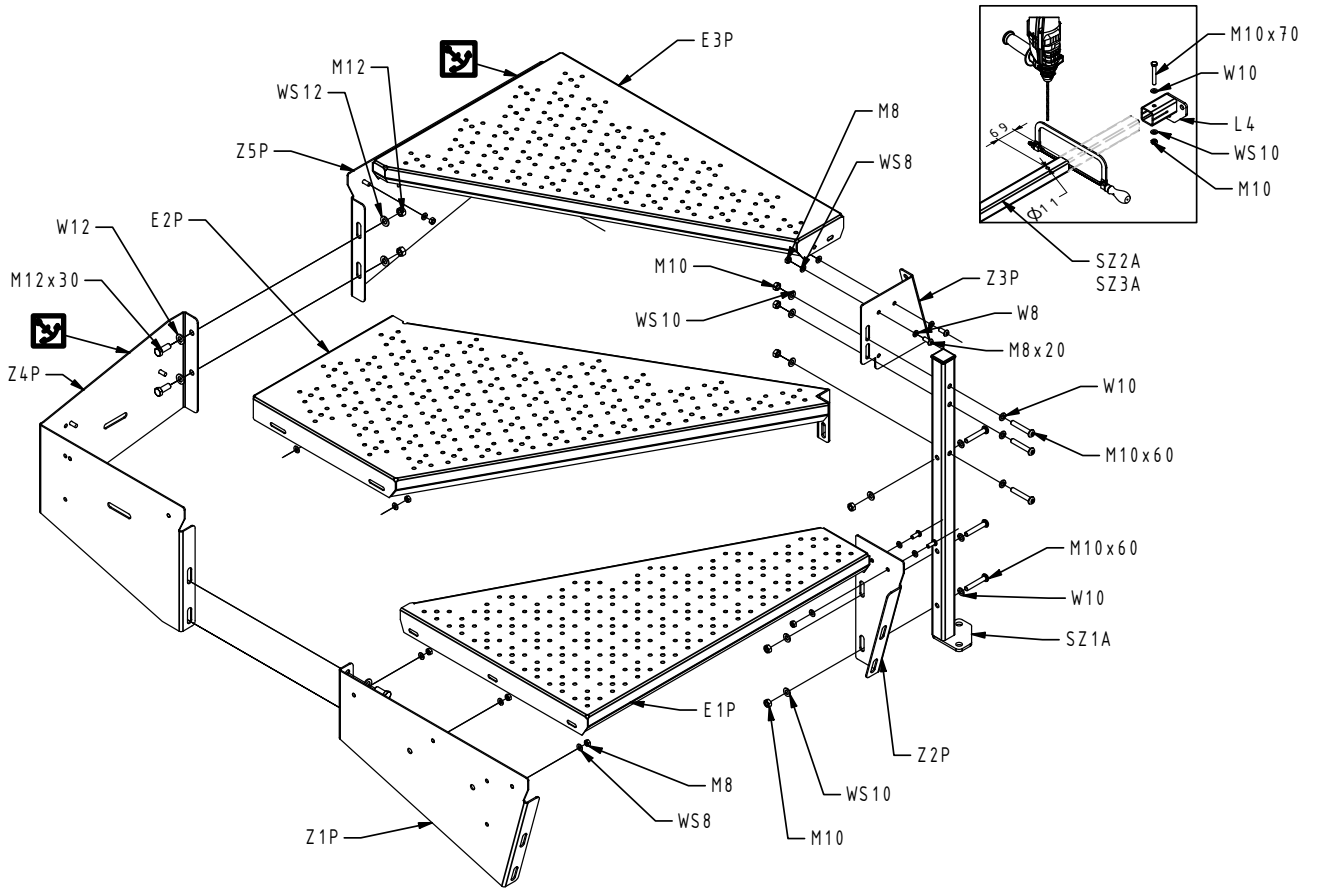

Wariant 14 / Variant 14 / Variante 14

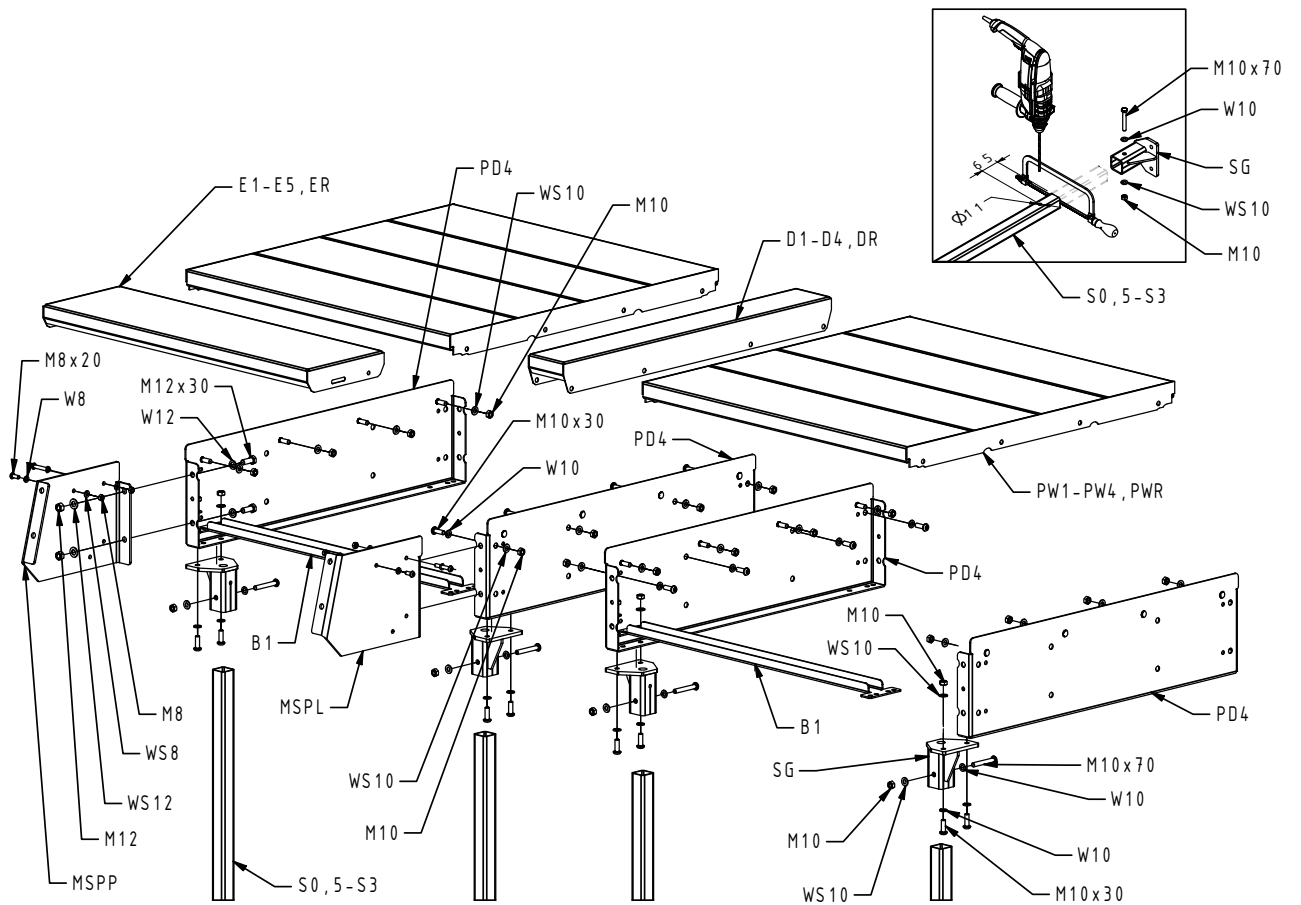

Wyprodukowano przez:
Produced by:
Hergestellt von:

WYTWÓRCA CERTYFIKOWANY
CERTIFIED MANUFACTURER
ZERTIFIZIERTER HERSTELLER

TLC Sp. z o.o.
ul. Chopina 25N
38-300 Gorlice



tlc.eu

info: +48 505 140 140

asta

SCHODY
MODUŁOWE

MODULAR
STAIRS

MODULTREPPE